

POINT 65°N
S W E D E N

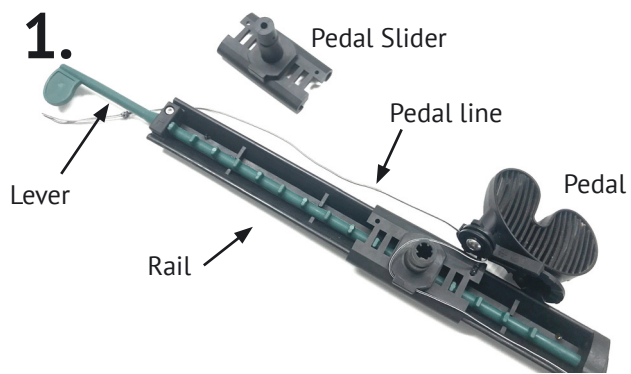

**Rudder pedal slider
exchange guide**

How to exchange the rudder pedal slider



Step by step guide on how to replace the Pedal slider on your rudder pedal. Start by unscrewing the pedal from the kayak using a phillips screw driver.



To exchange the Pedal slider you will need the following tools:
- 10mm socket wrench
- 4mm allen key
- Scissor

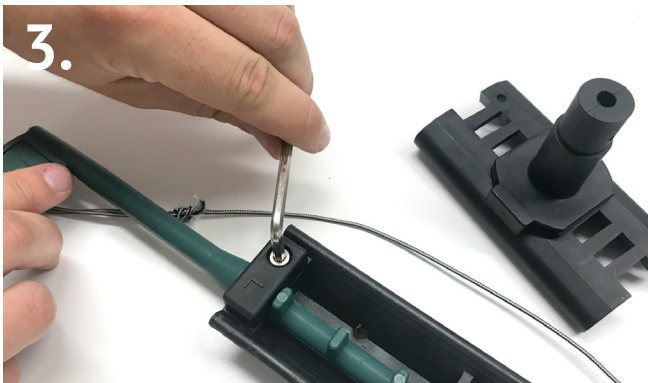

Use the allen key to unscrew the cover fitting as shown above.

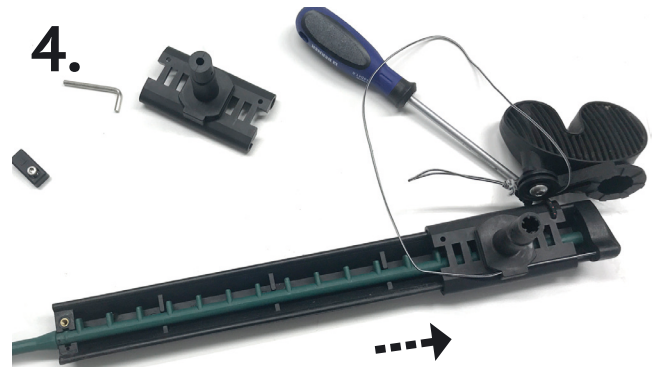

After unscrewing the cover fitting, move the slider all the way to the front of the pedal rail.

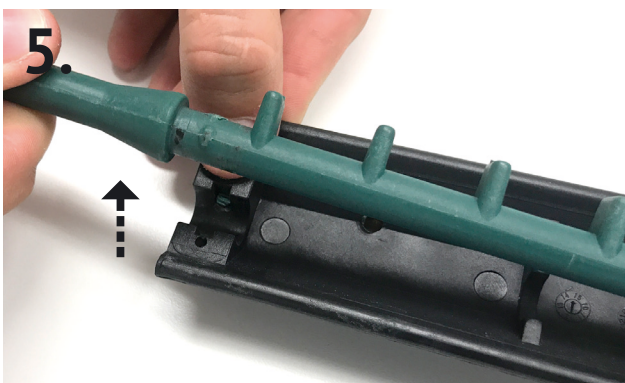

Lift the green lever out of the groove as shown above.

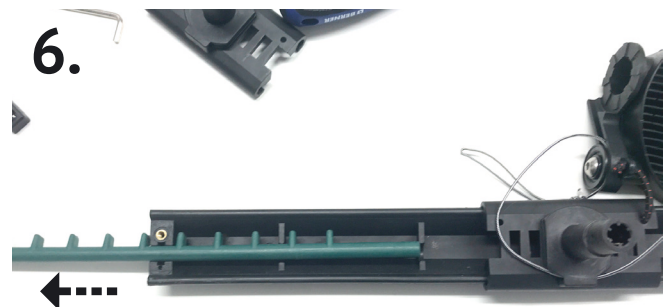

Pull out the green lever from underneath the slider and put aside.

7.

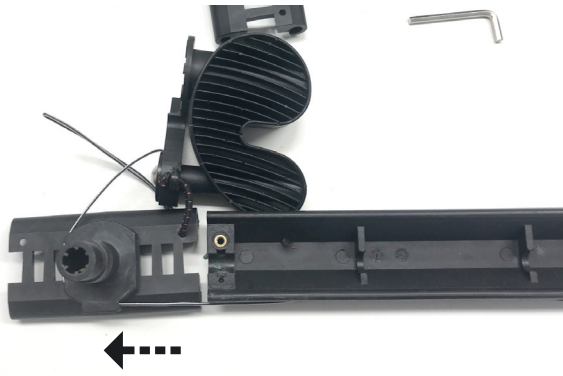

Slide off the pedal slider from the rail. Untie the knot at the loop on the pedal line and take off from pedal slider.

8.

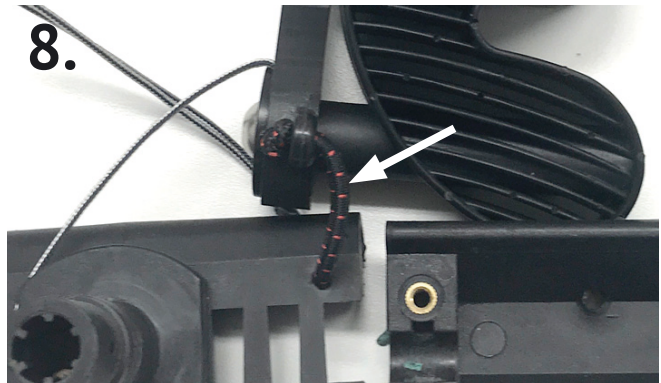

Cut off the black/red elastic line connecting the pedal to the old pedal slider.

9.



Use the Socket wrench/driver and allen key to loosen the nut inside the pedal and shake out the broken plastic pieces from the old pedal slider.

10.

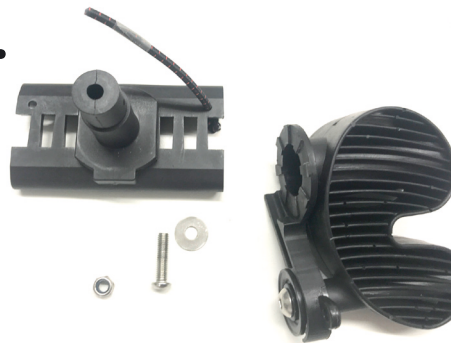

The new slider has an elastic line attached marked with tape, this is to show where the knot should be placed after inserting it into the pedal (this is done at the end of this manual).

11.



Drop the nut into the new slider.

12

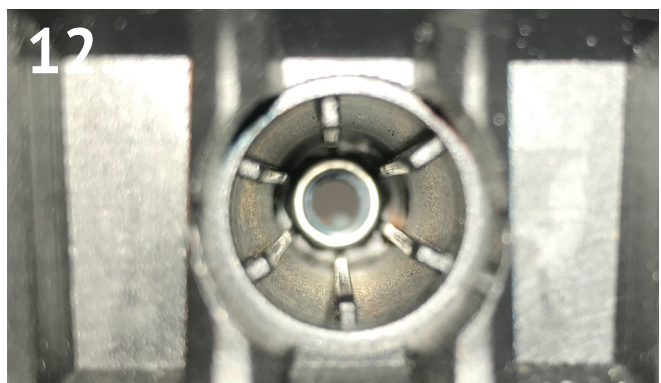

Make sure the nut is correctly inserted in the hole, don't force it, it should drop in easily, guided by the flanges around the sides.



13. Slide the pedal onto the axis of the pedal slider. Make sure to keep the pedal slider at an angle so that the nut doesn't move.



14. Screw in the screw lightly at first to make it catch on the nuts threads. Tighten the screw lightly, do not tighten hard!

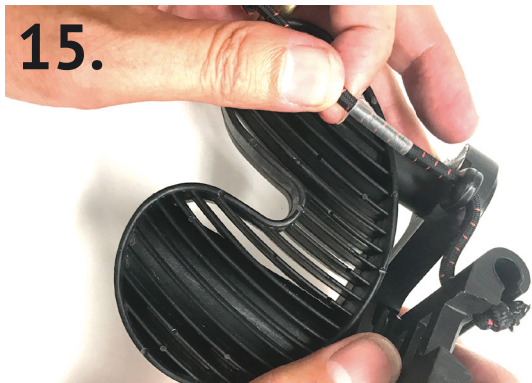

15. Pull the elastic line through the eyelet in the pedal carefully to make sure the tape marker doesn't peel off.



16. Make a knot at the edge of the tape closest to the eyelet and cut off the excess line.

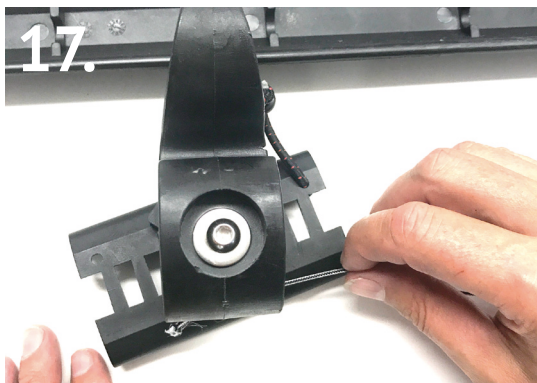

17. Thread the rudder line into the channel on the pedal slider under the pedal.



18. After threading the line through the channel, turn the slider around and put the pedal line through the pedal and pedal wheel as shown in the image above.

19.

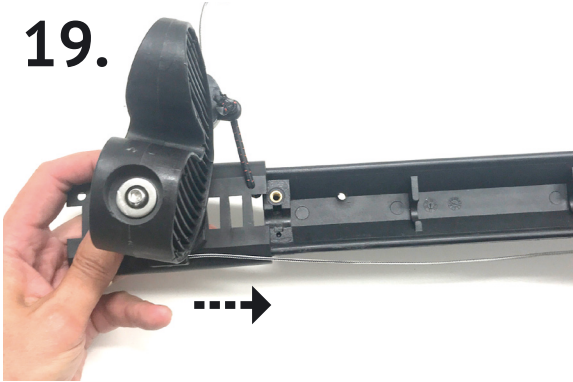

Slide the pedal slider onto the rail again

20.

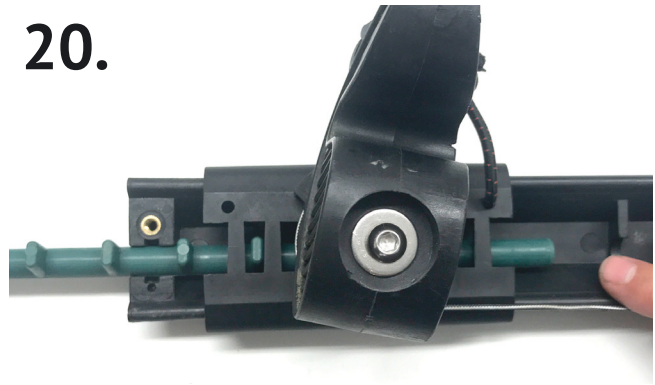

Slide in the lever underneath the pedal slider and turn it into lock position as shown above. Make sure the end of the lever sticks out as shown above on the right side.

21.



Push down the lever into the groove as shown above.

22.

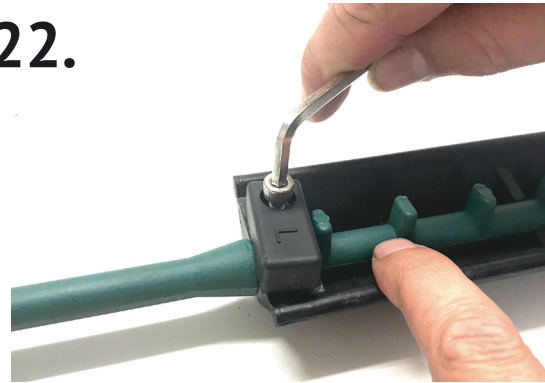

Add the cover fitting and screw tightly using the allen key.

23.

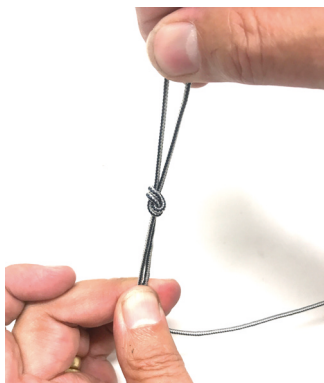

Make a loop at the end of the pedal line and make a know as shown above. Attach the pedal again onto your kayak!